

Ciclope Floor 90 Bilaterale Anthracite gray

Alessandro Pedretti

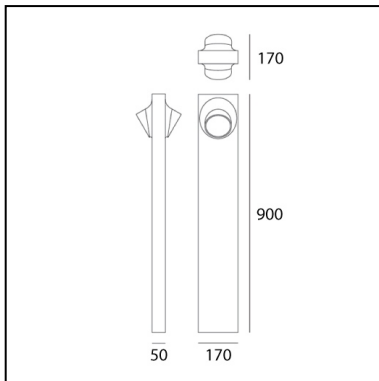

IP65   



LUMINAIRE

- Power Supply: **Electronic**
- Watt: **13W**
- Voltage: **220-240V**
- Delivered lumen output: **765lm**
- CCT: **3000K**
- Efficiency: **64%**
- Efficacy: **58.88lm/W**
- CRI: **90**

DESCRIPTION

Lighting system with diffuse unilateral or bilateral emission, with high-performance LED light sources. Light emission is obtained by the combination of six monochromatic LED light sources, a reflector and an opaline diffuser. Floor, wall or recessed installation. Available in two finishes: light grey and rust painted.

FEATURES

- Product Code: **T081420**
- Colour: **Anthracite gray**
- Installation: **BollardFloor**
- Material: **Composite technopolymer, polycarbonate, steel, aluminum**
- Series: **Architectural Outdoor**
- Environment: **Outdoor**
- Area contract: **null, Outdoor, Residential**
- Emission: **Direct**
- design by: **Alessandro Pedretti**

DIMENSIONS

- Length: **170 mm**
- Width: **170 mm**
- Height: **900 mm**

SOURCES INCLUDED

- Category: **Led**
- Number: **2**
- Watt: **6,5W**
- Color temperature (K): **3000K**
- CRI: **80**