

ANTIDARK

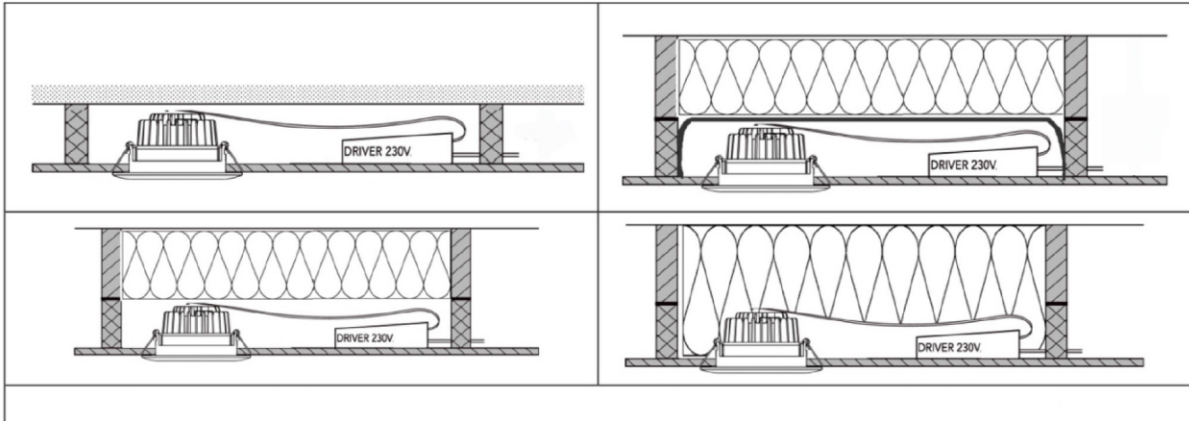
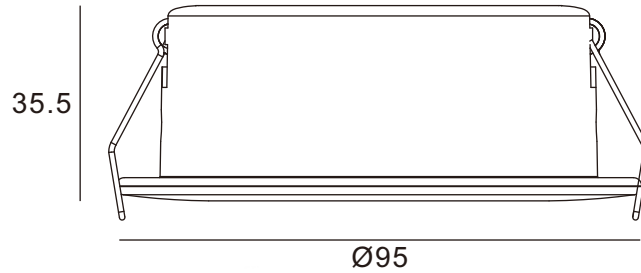

IMPORTANT INFORMATION:

1. Please read this instruction carefully before installation and keep it for future reference.
2. Please conform to the equipment instruction, installation is to be made by a professional.
3. Make sure correct voltage is applied before use and keep away from heat and vibrating sources.
4. The light source of this luminaire is not replaceable. When the light source reaches its end of life the whole luminaire shall be replaced.
5. For outdoor places ,only with a cover on the fixture top , such like the corridor and balcony.

MAIN PARAMETER:

Product:	2-260-60-1/2-260-60-2	2-260-61-1/2-260-61-2
Rated Voltage	AC 220-240V 50/60Hz	AC 220-240V 50/60Hz
LED Rated Power	5.25W	5.25W
System Power	7W	7W
LED	Epistar COB LED	Epistar COB LED
LED Driver	Constant Current 350mA	Constant Current 350mA
Color Temperature	2700K	3000K
Protection	Class II	Class II
Beam Angle	36°	36°
IP Rated	IP44	IP44
Operation Temperature	-25°C ~ 50°C	-25°C ~ 50°C
Cut-out Size:	Ø83mm	Ø83mm
Product Size:	Ø95mmxH35.5mm	Ø95mmxH35.5mm

INSTALLATION INSTRUCTIONS:

1. Always switch off the power supply before installation.

2. Make sure all parts are ready when open the box and prepare the installation tools the lighting needs.
3. Should be installed by qualified electricians.
4. If there is any damage on the housing or glass cover, should view it as disqualified product that cannot be used.

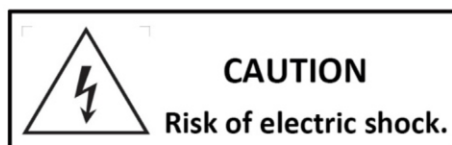
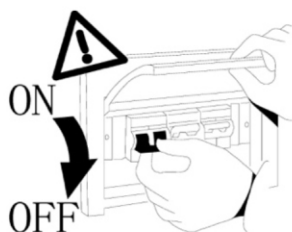

INSTALLATION STEPS:

1. Cutout for the downlight.

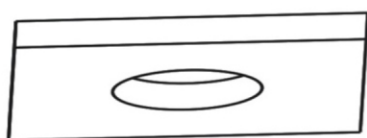

Cut-out: Ø83mm

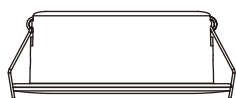

2. Connect Mains supply to the terminal block of LED driver. Slide the mounting spring clips into the ceiling cut-out and push the luminaire up into cutting hole. Ensure that it is securely located.

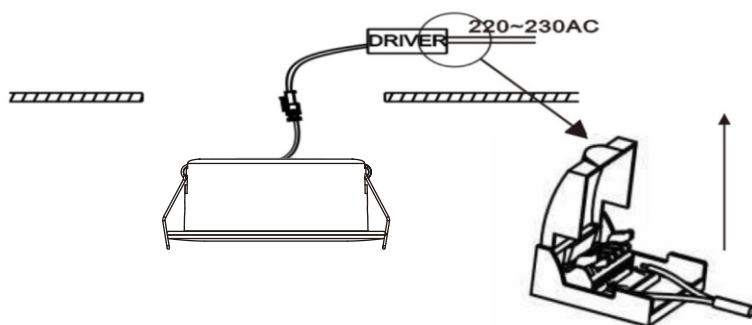

3. Switch on the power supply.

